

# SWITCHGEAR AND PROTECTION

Dr.M.Manjula  
Professor

# Contents

- **Circuit Breaker**
- **Formation of arc during circuit breaking**
- **Arc interruption**
- **Circuit Breaker rating**
- **Air Circuit Breaker and**
- **Air Blast Circuit Breaker**

- **Minimum Oil Circuit Breaker or MOCB**
- **Vacuum Circuit Breaker or VCB**
- **SF<sub>6</sub> Circuit Breaker**
- **D.C circuit breakers**
- **HRC Fuse or High Rupturing Capacity Fuse**

# Circuit Breaker

- Circuit breakers provide a manual means of energizing and de-energizing a circuit.
- Unlike fuses, which must be replaced when they open, a circuit breaker can be reset once the over current condition has been over
- Pushing the handle to the “OFF” position and then back to the “ON” position restores the circuit.

# The fundamental of Circuit breaker operation

In the following illustration, an AC motor is connected through a circuit breaker to a voltage source.

- When the circuit breaker is closed, a complete path for current exists between the voltage source and the motor allowing the motor to run.

- Opening the circuit breaker breaks the path of current flow and the motor stops.
- The circuit breaker **automatically opens** when it senses a fault.
- After the fault has been cleared, the breaker can be closed, allowing the motor to operate.

# Circuit Breaker

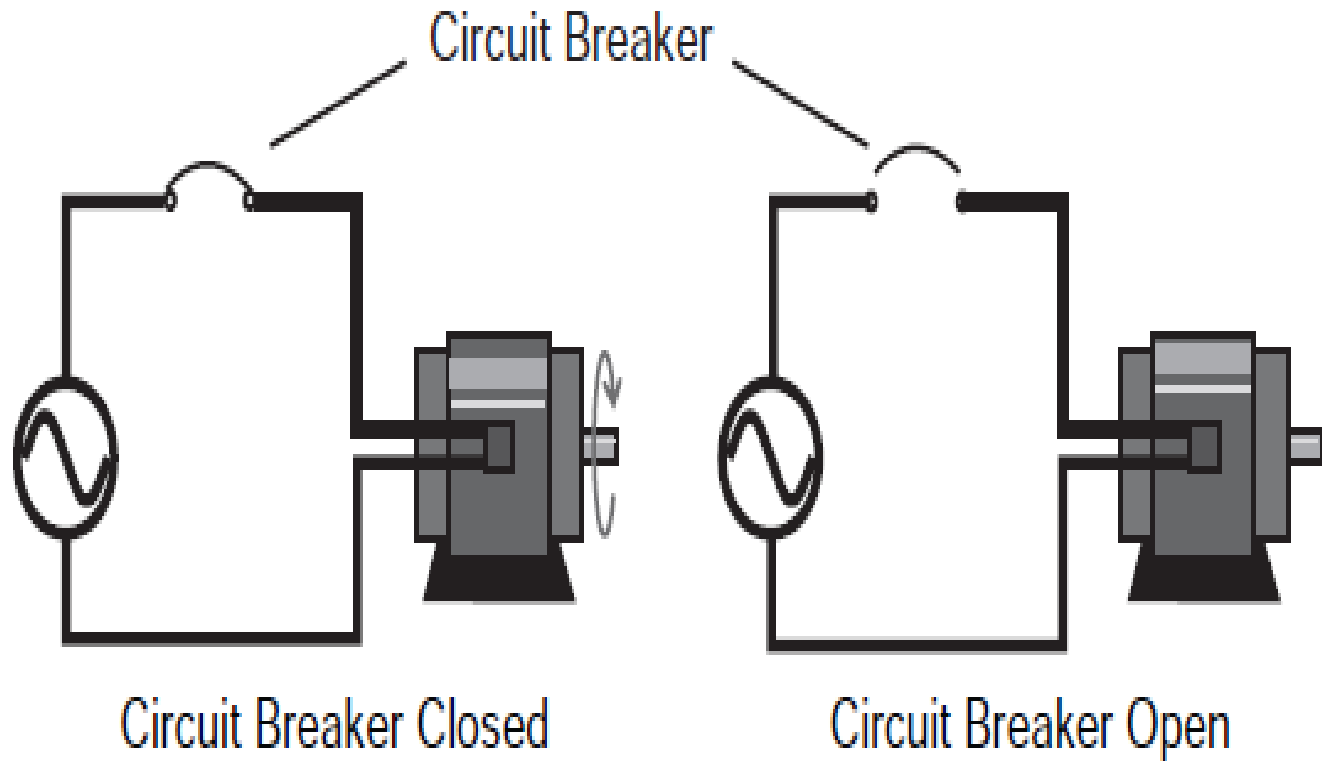

# Circuit Breaker

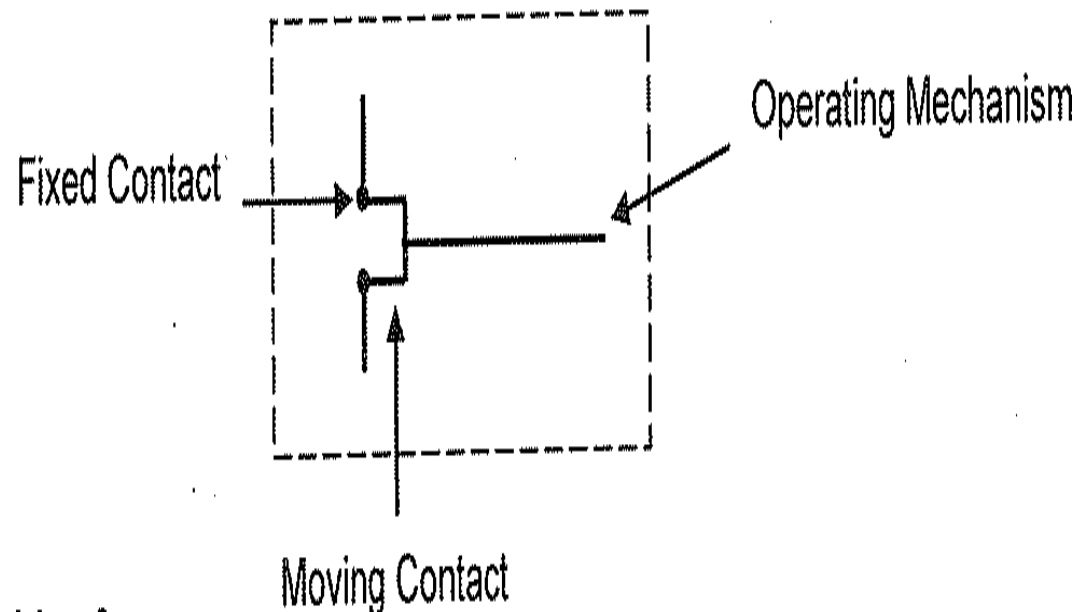



# Circuit Breaker

*Concept Structure*

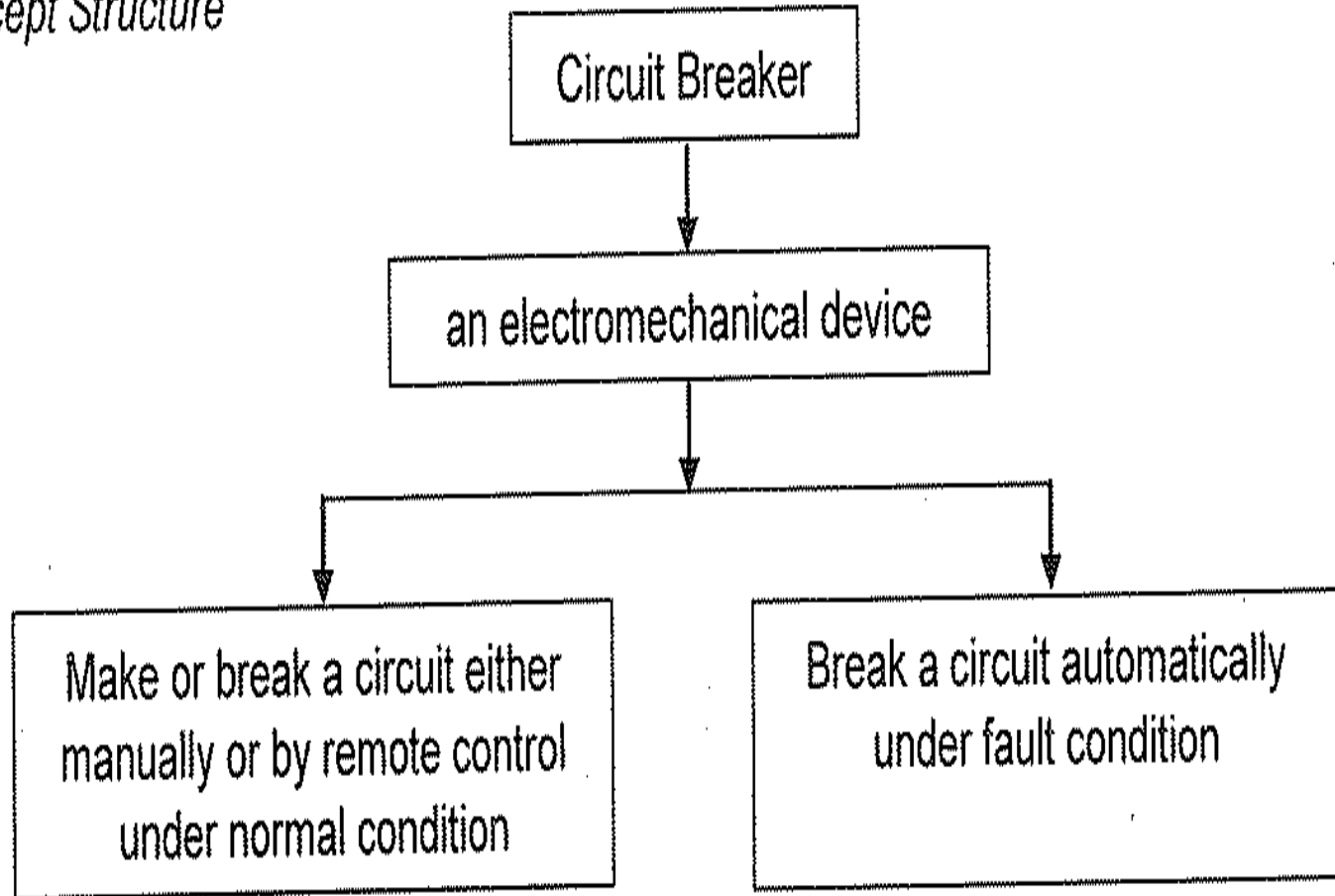

# Miniature Circuit Breaker



# Types of circuit breakers

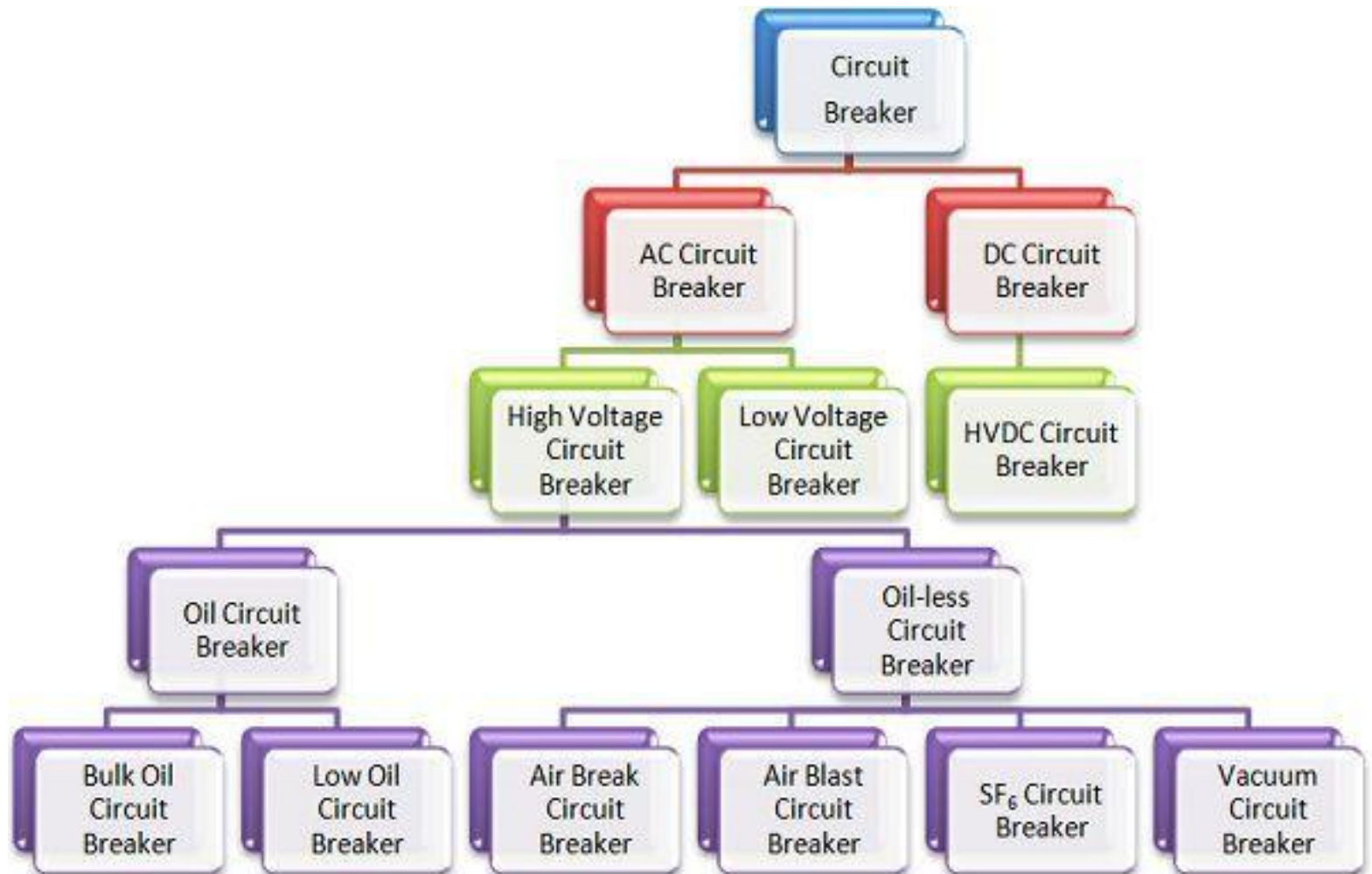

Circuit Globe

# Types of Circuit Breaker



MCB



ELCB



RCCB



MCCB



ACB



VCB



MOCB



BOCB



SF<sub>6</sub>CB

# Parts of a circuit breaker

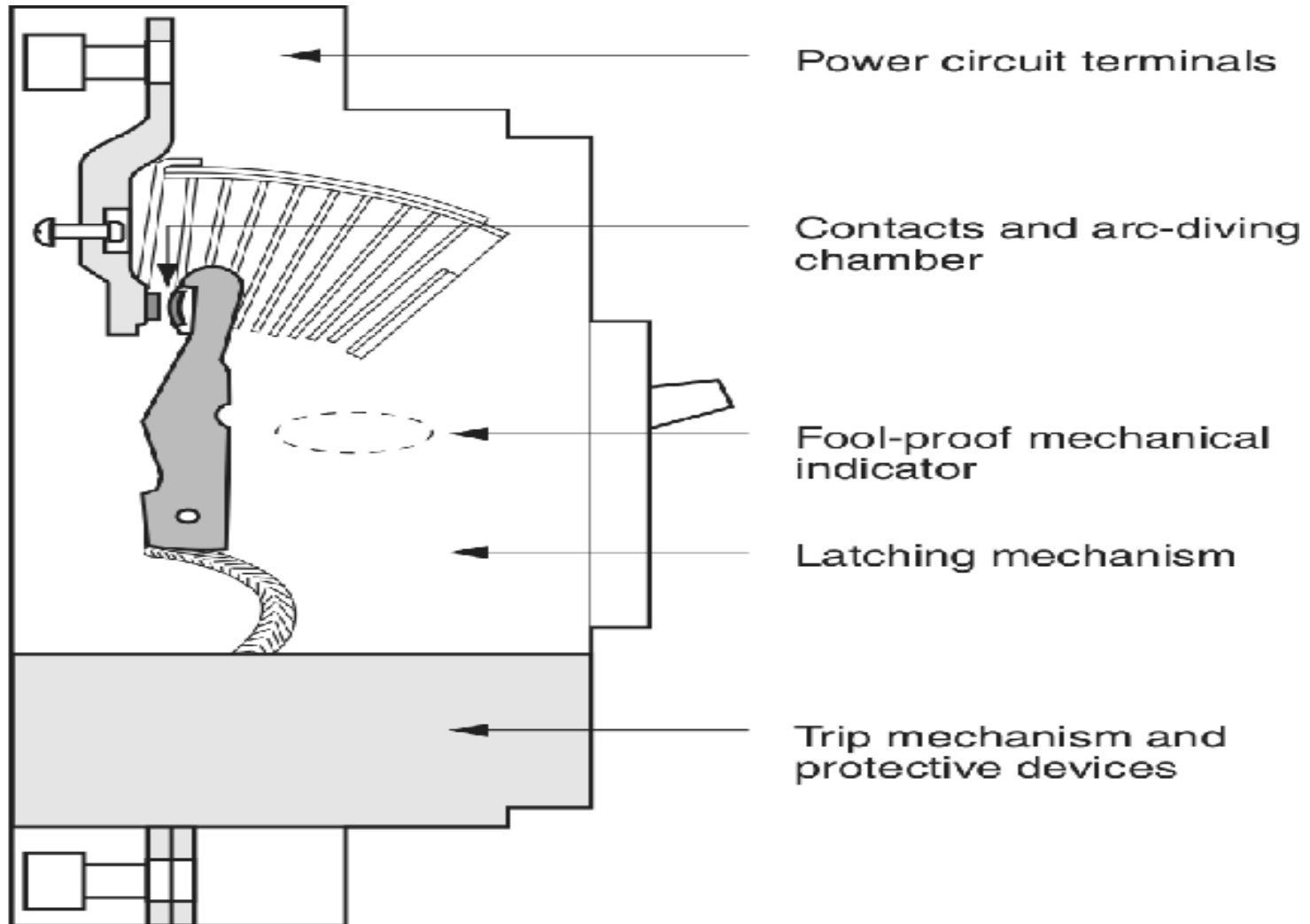

# Parts of a circuit breaker

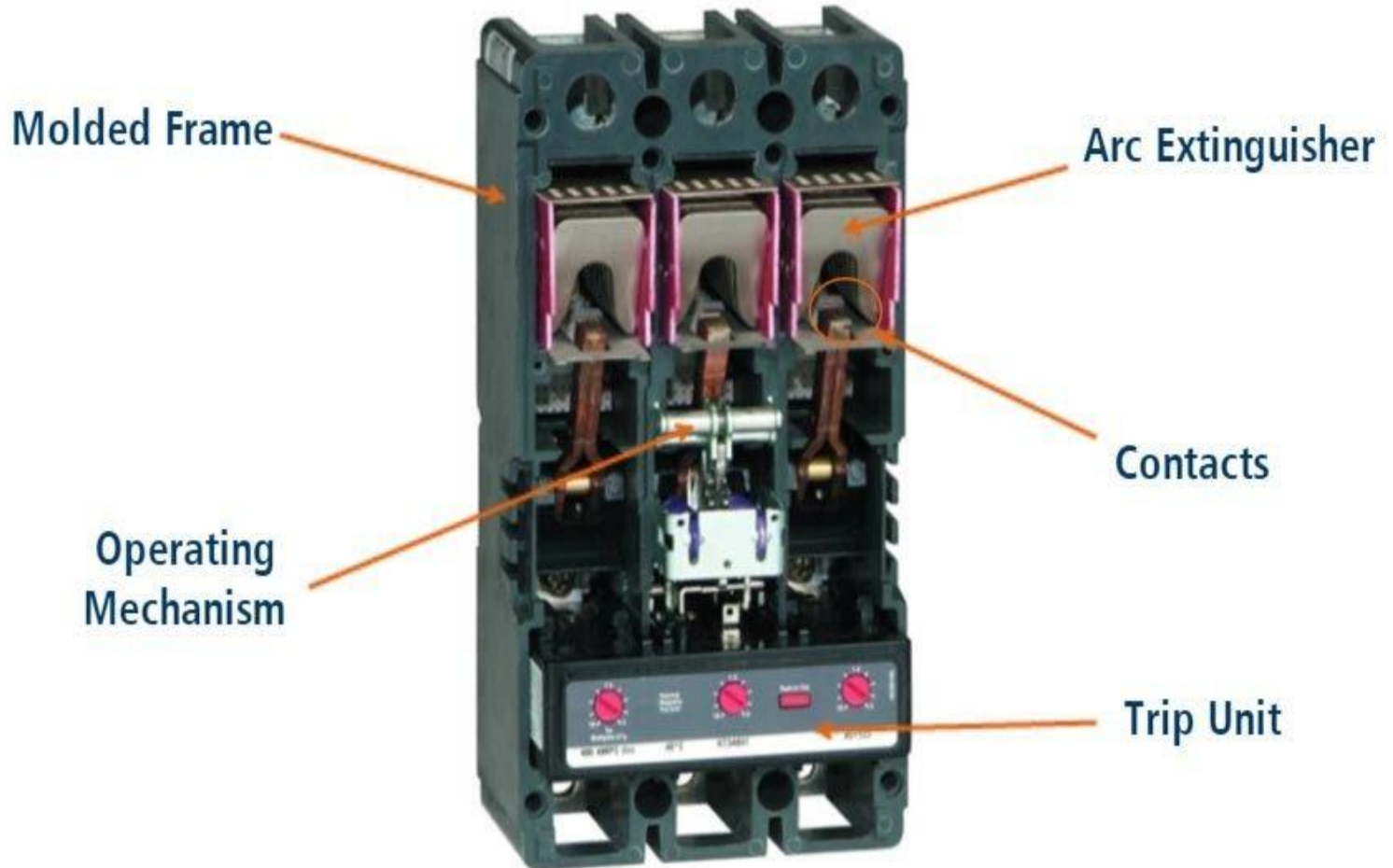

# Formation of arc during circuit breaking

## *The phenomena of Arc*

- During opening of current carrying contacts in a circuit breaker
- The medium in between opening contacts become highly ionized through which the interrupting current gets low resistive path and continues to flow through this path even after the contacts are physically separated.
- During the flowing of current from one contact to other the path becomes so heated that it glows in the form of an arc.

# Arc during circuit breaking

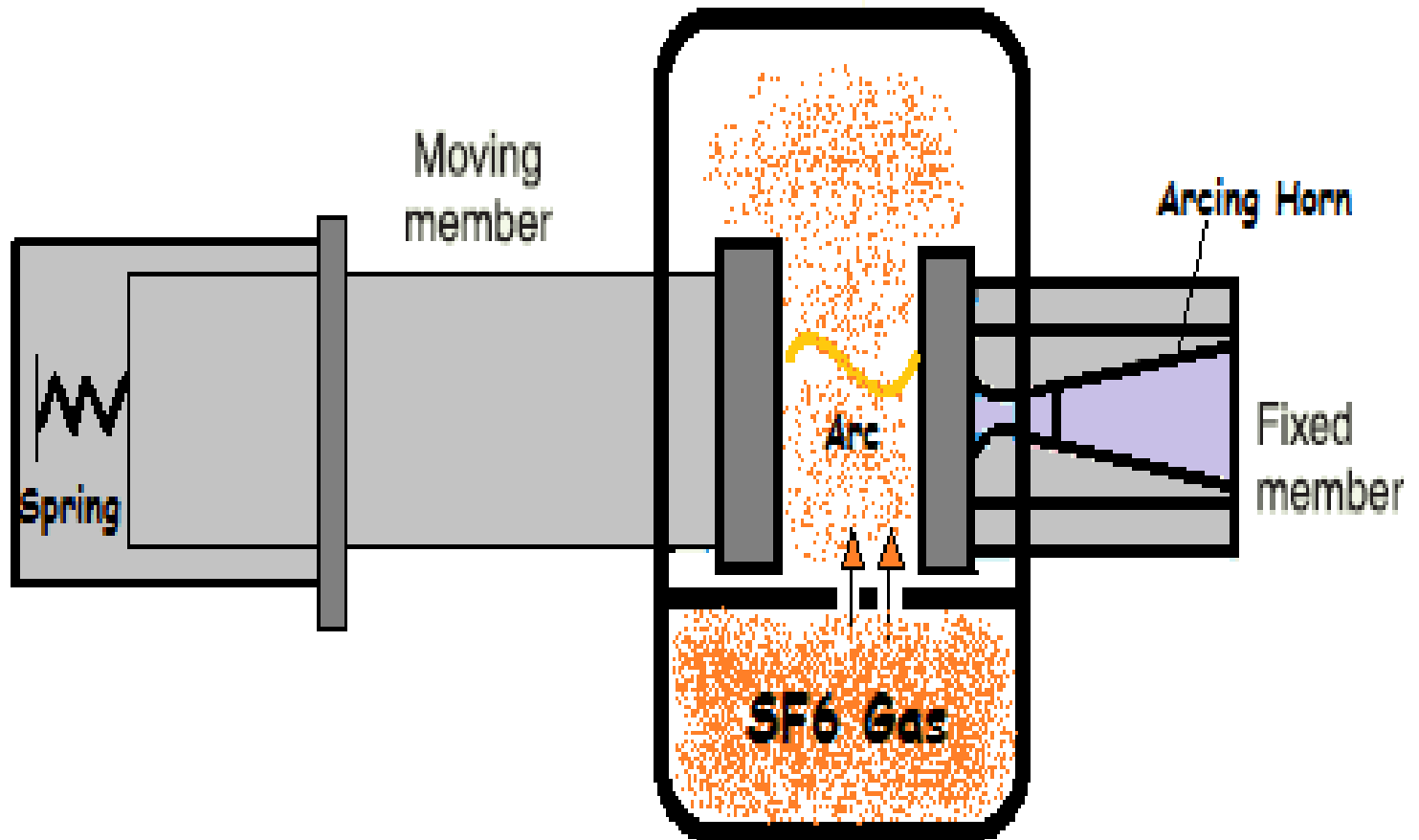



# Vacuum Circuit Breaker

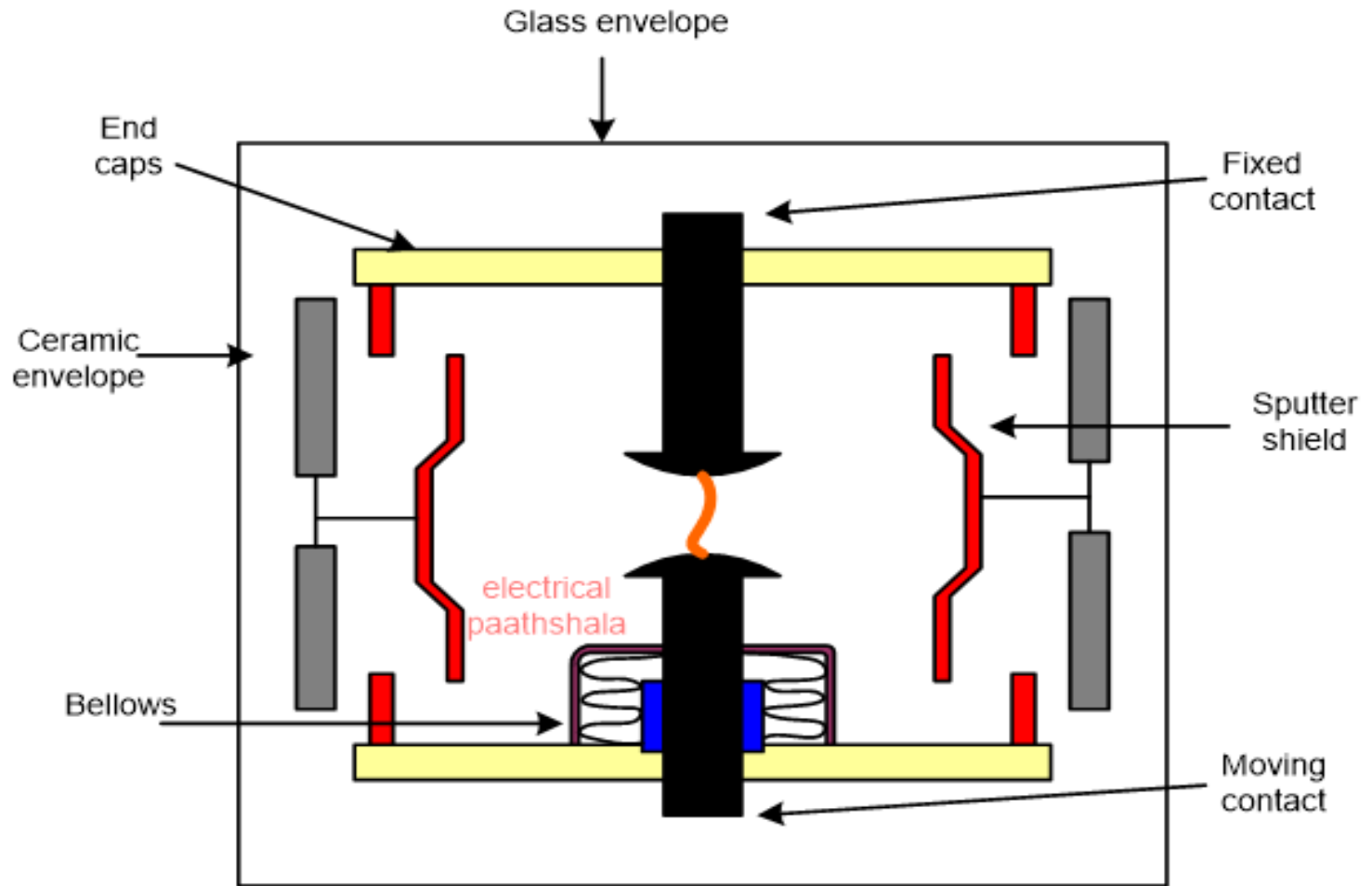

**Vacuum Circuit Breaker**

# ***Arc in circuit breaker***

- Whenever, the contacts of circuit breaker open while carrying load there is an arc in the medium between the separating contacts of the circuit breaker.
- As long as this arc is sustained in between the contacts, the current through the circuit breaker will not be interrupted totally.

- For total interruption of current, the arc needs to be quenched as quickly as possible.
- The main designing criteria of a circuit breaker is to provide appropriate technology of arc quenching in circuit breaker to fulfill quick and safe current interruption.
- So before going through different arc quenching techniques employed in circuit breaker, it is first necessary to understand the phenomena of arc in circuit breaker.

# ***Thermal ionization of gas***

- There are numbers of free electrons and ions present in the medium separating the two contacts of the circuit breaker.
- These free electrons and ions are so few in number that they are insufficient to sustain conduction of electricity.

- The gas molecules move randomly at room temperature.
- It is found an air molecule at a temperature of  $300^{\circ}\text{K}$  (Room temperature) moves randomly with an approximate average velocity of 500 meters/second and collides other molecules at a rate of  $10^{10}$  times/second.

- 
- These randomly moving molecules collide each other in very frequent manner but the kinetic energy of the molecules is not sufficient to extract an electron from atoms of the molecules.
  - If the temperature is increased the air will be heated up and consequently the velocity of the molecules increased.

- 
- Higher velocity means higher impact during inter molecular collision.
  - During this situation some of the molecules are disassociated in to atoms.
  - If temperature of the air is further increased many atoms are deprived of valence electrons and make the gas ionized.

- Then this ionized gas can conduct electricity because of sufficient free electrons.
- This condition of any gas or air is called plasma.
- This phenomenon is called thermal ionization of gas.



# **Interruption of Arc**

- **Ionization of gas due to electric field**
- **Deionization of gas**
- **Methods of Deionization**

# ***Ionization due to electric field***

- There are always some free electrons and ions presents in the air or gas but they are insufficient to conduct electricity.
- Whenever these free electrons come across a strong electric field, these are attracted by the field and acquire sufficiently high velocity.

- In other words, the electrons are accelerated along the direction of the electric field due to high potential gradient.
- During their travel these electrons collide with other atoms and molecules of the air or gas and extract valance electrons from their orbits.
- After extracted from parent atoms, the electrons will also run along the direction of the same electric field due to potential gradient.

- These electrons will similarly collide with other atoms and create more free electrons which will also be directed along the electric field.
- Due to this conjugative action the numbers of free electrons in the gas will become so high that the gas starts conducting electricity.
- This phenomenon is known as ionization of gas due to electron collision.

# Deionization of gas

- If all the causes of ionization of gas are removed from an ionized gas it rapidly come back to its neutral state by recombination of the positive and negative charges.
- The process of recombination of positive and negative charges is known as deionization process.

- In deionization by diffusion, the negative ions or electrons and positive ions move to the walls under the influence of concentration gradients and thus completing the process of recombination.

# ***Role of arc in circuit breaker***

- When two current carrying contacts open, an arc bridges the contact gap
- The current gets a low resistive path to flow so there will not be any sudden interruption of current.
- As there is no sudden and abrupt change in current during opening of the contacts, there will not be any abnormal switching over voltage in the system.

- In the case of alternating current arc is momentarily extinguished at every current zero.
- After crossing every current zero the medium between separated contacts gets ionized again during next cycle of current and the arc in circuit breaker is reestablished.



- To make the interruption complete and successful, this re-ionization in between separated contacts to be prevented after a current zero.
- If arc in circuit breaker is absent during opening of contacts, there would be sudden and abrupt interruption of current which causes a huge switching over voltage sufficient to severely stress the insulation of the system.

# ***Arc column characteristics***

- The mobility of charged particles depends upon the temperature, pressure of the gas and as well as nature of the gas.
- Again the mobility of gas particles determines the degree ionization of gas.

- So we understand that ionization process of gas depends upon nature of gas (heavier or lighter gas particles), pressure of gas and temperature of gas.
- As we said earlier the intensity of arc column depend up on the presence of ionized media between separated electrical contacts

- Hence, special attention should be given in reducing ionization or increasing deionization of media between contacts.
- That is why the main designing feature of circuit breaker is to provide different pressure control methods, cooling methods for different arc media in between circuit breaker contacts.



The basic construction of any circuit breaker requires the separation of contacts in an insulating fluid which serves two functions here:

- It extinguishes the arc drawn between the contacts when the circuit breaker opens.
- It provides adequate insulation between the contacts and from each contact to earth.



Many insulating fluids are used for arc extinction and the fluid chosen depends upon the rating and type of circuit breaker

- The insulating fluids commonly used for circuit breaker are:
  - (i) Air at atmospheric pressure.
  - (ii) Compressed air.
  - (iii) Oil which produces hydrogen for arc extinction.
  - (iv) Ultra high vacuum.
  - (v) Sulphur hexafluoride (SF<sub>6</sub>).



The gases which have been considered for circuit breaker are:

(i) Simple gases — air, oxygen, hydrogen, nitrogen, carbon dioxide; and

(ii) electronegative gases — sulphur hexafluoride, arcton.



# Properties required of a gas for circuit breaker use are:

(i) High dielectric strength.

(ii) Thermal and chemical stability.

(iii) Non-inflammability.

(iv) High thermal conductivity: This assists cooling of current carrying conductors immersed in the gas and also assists the arc extinction process.

(v) Arc extinguishing ability: It should have a low dissociation temperature, a short thermal time constant (ratio of energy contained in an arc column at any instant to the rate of energy dissipation at the same instant) and should not produce conducting products such as carbon during arcing.

(vi) Commercial availability at moderate cost: Of the simple gases air is the cheapest and most widely used for circuit breaking.

# Different insulating materials

- Hydrogen has better arc extinguishing property but it has lower dielectric strength as compared with air.
- Also if hydrogen is contaminated with air, it forms an explosive mixture.
- Nitrogen has similar properties as air, CO<sub>2</sub> has almost the same dielectric strength as air but is a better arc extinguishing medium at moderate currents.

- 
- Oxygen is a good extinguishing medium but is chemically active.
  - SF<sub>6</sub> has outstanding arc quenching properties and good dielectric strength.
  - Of all these gases SF<sub>6</sub> and air are used in commercial gas blast circuit breakers.

# Properties of Insulating materials

## Compressed Air

- Air at atmospheric pressure is 'free' but dry air costs a lot when stored at say 75 atmospheres.
- The compressed air supply system is a vital part of an air blast circuit breaker
- Moisture from the air is removed by refrigeration, by drying agents or by storing at several times the working pressure and then expanding it to the working pressure for use in the circuit breaker

- The relative cost of storing the air reduces with increase in pressure.
- If the air to be used by the breaker is at 35 kg/cm<sup>2</sup> it is common to store it at 210 kg/cm<sup>2</sup>.
- Air has an advantage over the electronegative gases in that air can be compressed to extremely high pressures at room temperature and then its dielectric strength even exceeds that of other gases.

# SF<sub>6</sub> gas

- The dielectric strength of SF<sub>6</sub> (Sulphur hexafluoride) at normal pressure and temperature is 2 to 3 times that of air and at 2 atm its strength is comparable with the transformer oil.
- Although SF<sub>6</sub> is a vapor, it can be liquefied at moderate pressure and stored in steel cylinders.
- Even though SF<sub>6</sub> has better insulating and arc quenching properties than air at an equal pressure

- However, it has the important disadvantage that it cannot be used much above 14 kg/cm<sup>2</sup> unless the gas is heated to avoid liquefaction.
- Circuit breakers, using SF<sub>6</sub> at 14 kg/cm<sup>2</sup>, have heaters installed in the high pressure reservoir.



- The interrupting capacity of a circuit breaker is approximately directly proportional to the gas pressure;
- Therefore, it is possible for a compressed-air break to have a higher interrupting capacity than an SF6 break at the expense of increased gas pressure.
- The choice between the two gases depends to a large extent on the cost of the complete equipment.

# Arc in oil

In an oil circuit breaker, the heat of the oil decomposes the oil which boils at  $658^{\circ}\text{K}$ .

The gases liberated are approximately

- (1) Hydrogen 70%;
- (2) Acetylene 20%;
- (3) Methane 5%; and
- (4) Ethylene 5%

- The temperature about the arc is too high for the three last-named gases to exist and the arc itself runs into a mixture of hydrogen, carbon and copper vapor at temperature above 6000°K.
- The hydrogen being a diatomic gas gets dissociated into the atomic state which changes the characteristics of the arc on account of its associated change in its thermal conductivity.

- The outcome of this is that the discharge suddenly contracts and acquires an appreciably higher core temperature.
- In certain cases the thermal ionization may be so great that the discharge runs with a lower voltage which may stop the ionization due to the electric field strength.
- The transition from the field ionization to thermal ionization is most marked in hydrogen and, therefore, in oil circuit breakers.

# Initiation of the Arc

- The separation of the C.B. contacts which are carrying current gives rise to an arc without changing much the current waveform.
- Initially when the contacts just begin to separate the magnitude of current is very large but the contact resistance being very small, a small voltage appears across them.
- But the distance of separation being very very small, a large voltage gradient is set up which is good enough to cause ionization of the particles between the contacts.

- Also it is known that with the copper contacts which are generally used for the circuit breakers very little thermal ionization can occur at temperature below the melting point.
- For effective field emission the voltage gradient required is  $10^6$  V/cm.
- From this it is clear that the arc is initiated by the field emission rather than the thermal ionization.
- This high voltage gradient exists only for a fraction of a micro-second.

- 
- But in this short period a large number of electrons would have been liberated from the cathode and these electrons while reaching anode, on their way would have collided with the atoms and molecules of the gases.
  - Thus each emitted electron tends to create others and these in turn derive energy from the field and multiply.
  - In short, the work done by the initially emitted electrons enables the discharge to be maintained.

- Finally, if the current is high, the discharge attains the form of an arc having a temperature high enough for thermal ionization, which results in lower voltage gradient.
- Thus an arc is initiated due to field effect and then maintained due to thermal ionization.



# Deionization of Arc

As discussed , the arc consists of ionized particles of gases.

This arc can be interrupted if the contact gap could be deionized.



The process of deionization is possible in the following ways:

- (i) high pressure,
- (ii) forced convection and turbulence,
- (iii) arc splitting.

# Deionization of gas due to increasing pressure

- If pressure of the arc path increases, the density of the ionized gas is increased which means, the particles in the gas come closer to each other and as a result the mean free path of the particles is reduced.

- This increases the collision rate and at every collision the charged particles loss their directed velocity along electric field and again they are re-accelerated towards field.
- It can be said that over all mobility of the charged particles is reduced so the voltage required to maintain the arc is increased.

- 
- Another effect of the increased density of particles is a higher rate of deionization of gas due to the recombination of oppositely charged particles.

# Forced Convection and Turbulence

- When a gas blast is directed along a discharge, efficient cooling is obtained.
- In case of oil circuit breaker the hydrogen gas which has better thermal conductivity flows along the discharge.
- If the gas blast is axially directed, this not only gives cooling action but compels arc to shrink in diameter which in turn raises the temperature of the core of the arc.

- 
- The gases being generated at high pressure there will be turbulence near the surface of the arc and under certain conditions this effect may be used in the process of deionization especially in the circuit breaker where gas blast is used for extinction of the arc.

# Arc Splitting

There are two methods:

(1) The arc is forced into an arrangement of splitters by which the arc is lengthened and the cooling is improved because of contacts with the splitters.



(2) The arc is made to split into relatively smaller arcs.

- The idea here is to ensure that the sum of the cathode-anode voltage drops of short length should be more than the supply voltage;
- There by the energy fed to the arc will be reduced.

# ***Methods of arc interruption***

There are two methods by which interruption is done.

1. High resistance method.

2. Low resistance method or zero interruption method.

# High resistance method.

- In this method the arc resistance is increased in time to such a high value that it forces the current to reach zero without possibility of arc being re-struck thereafter.
- The rate at which the resistance is increased or the current is decreased is not abnormal so as to cause harmful induced voltages in the system.

- 
- The arc resistance may be increased due to any or all of the deionizing methods discussed earlier i.e., cooling, lengthening and splitting of the arc.
  - Because of the resistive nature of the arc discharge, most of the energy in the system will be received by the circuit breaker.

- Therefore, while designing the circuit breaker, provision of mechanical strength to withstand such sudden release of large quantities of energy must be made.
- This is the main drawback of this method of arc interruption.
- This method is, therefore, used for low and medium power a.c. circuit breakers and in d.c. circuit breakers.

# Limitations of high resistance method:

- Arc discharge has a resistive nature due to this most of the energy is received by circuit breaker itself
- Hence proper care should be taken during the manufacturing of circuit breaker like mechanical strength etc.
- Therefore this method is applied in dc power circuit breaker low and medium ac power circuit breaker.

# Low resistance or current zero interruption:

- This method is used only in A.C. circuit interruption because there is natural zero of current present in such systems.
- In case of a 50Hz supply there are 100 zeros per second.

- This property of A.C. circuit is exploited for interruption purposes and the current is not allowed to rise again after a zero occurs.
- Also it is neither necessary nor desirable to cut off the current at any other point on the A.C. wave because this will induce high voltages in the system.





There are two theories which explains the phenomenon of arc extinction:

- Energy balance theory
- Voltage race theory.

# Terminology

- ***Restriking voltage*** : It is defined as the *voltage* that appears across the breaking contact at the instant of arc extinction.
- ***Recovery voltage*** : It is defined as the *voltage* that appears across the breaker contact after the complete removal of transient oscillations and final extinction of arc has resulted in all the poles.

- **Active recovery voltage** : It is defined as the instantaneous recovery voltage at the instant of arc extinction.
- **Arc voltage** : It is defined as the voltage that appears across the contact during the arcing period, when the current flow is maintained in the form of an arc.
- It assumes low value except for the point at which the voltage rise rapidly to a peak value and current reaches to zero.

- 
- The ionization at current zero depends upon the voltage appearing between the contacts.
  - This voltage is known as restriking voltage which depends upon the power factor and other factors of the circuit like the inductance and capacitance.

- The instantaneous recovery voltage is given by

$$V_{ar} = K V_m \sin \varphi$$

where  $K = 1$  if the three-phase fault is also grounded and  $K = 1.5$  if the three-phase fault is isolated.

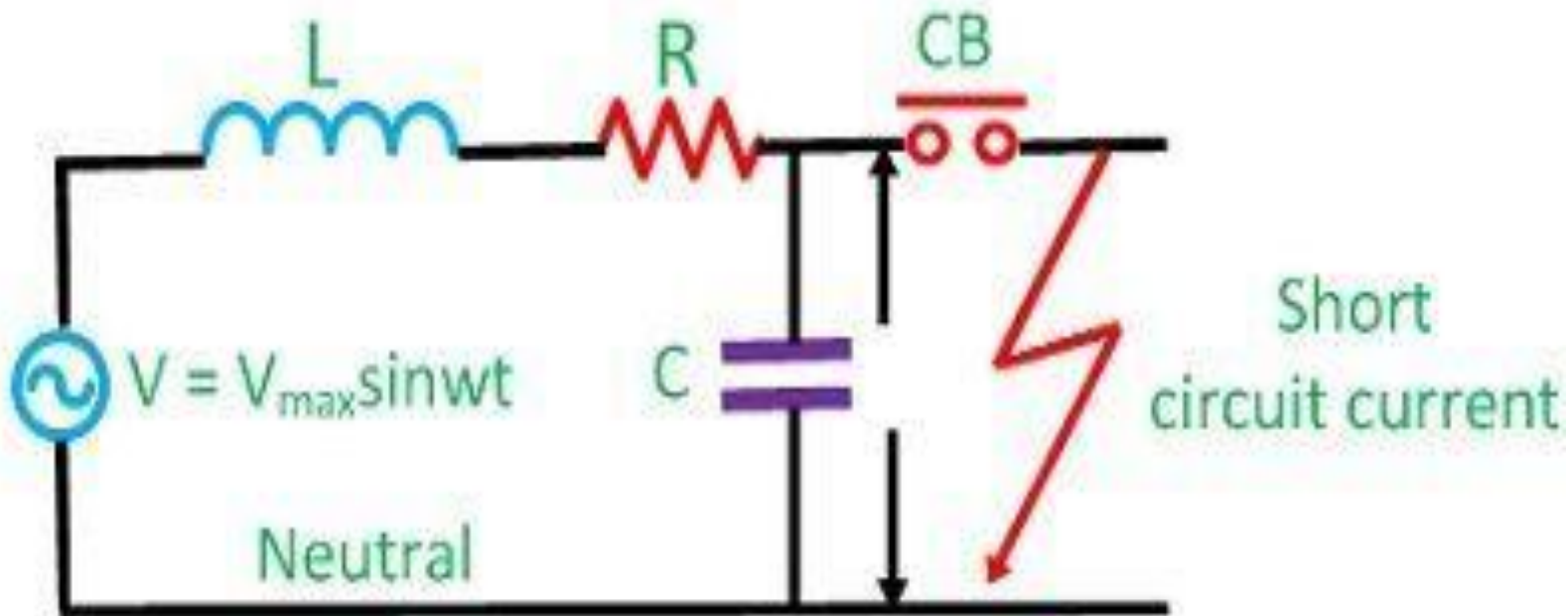

## Fault and its Equivalent Circuit

Circuit Globe

The expression for voltage is given by  
(for a lossless system)

$$v = V (1 - \cos t) / LC$$

where  $v$  = restriking voltage at any instant  $t$ ,

$V$  the value of voltage at the instant of interruption

and  $L$  and  $C$  are the series inductance and shunt capacitance up to the fault point.

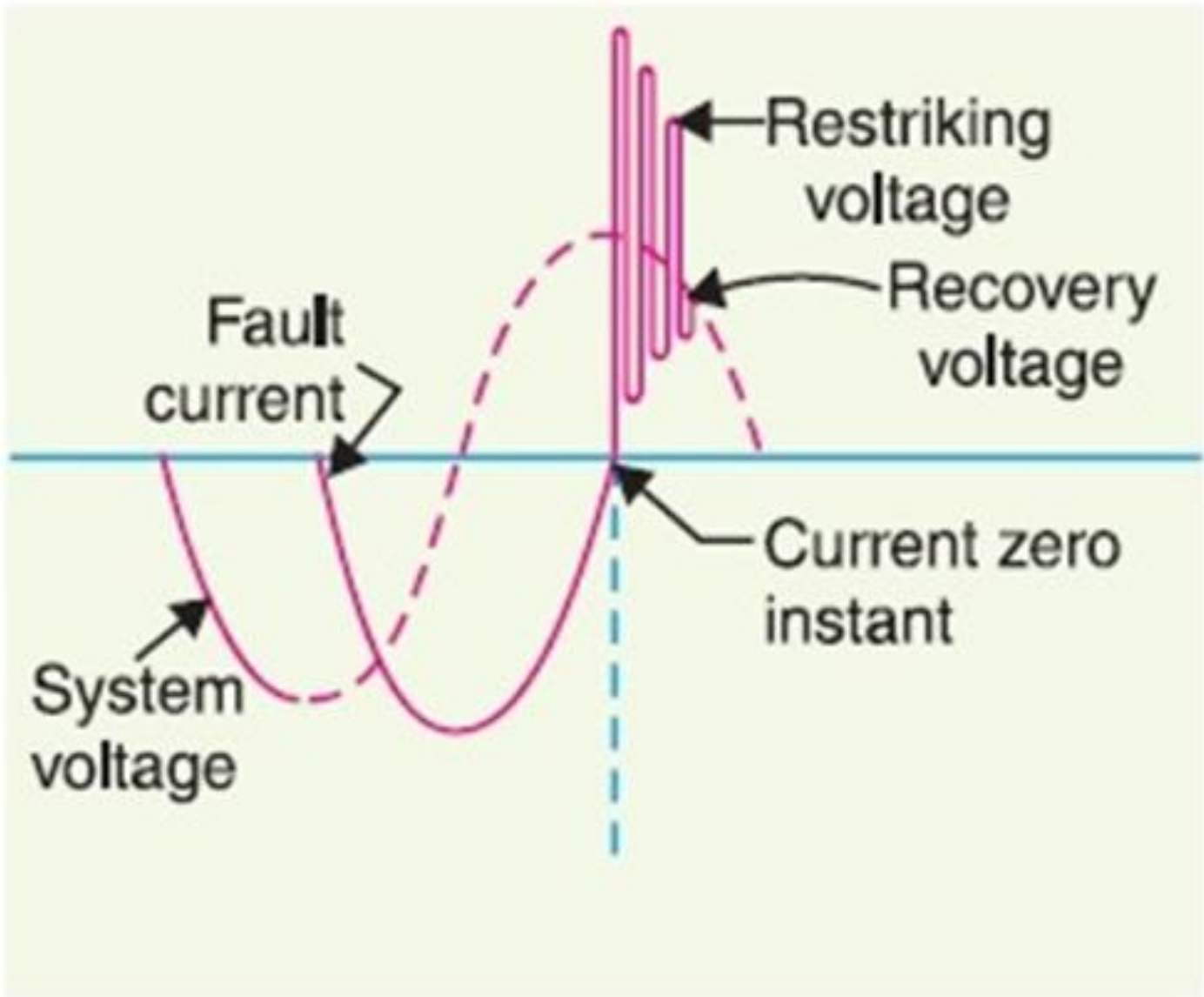



# Arc Voltage

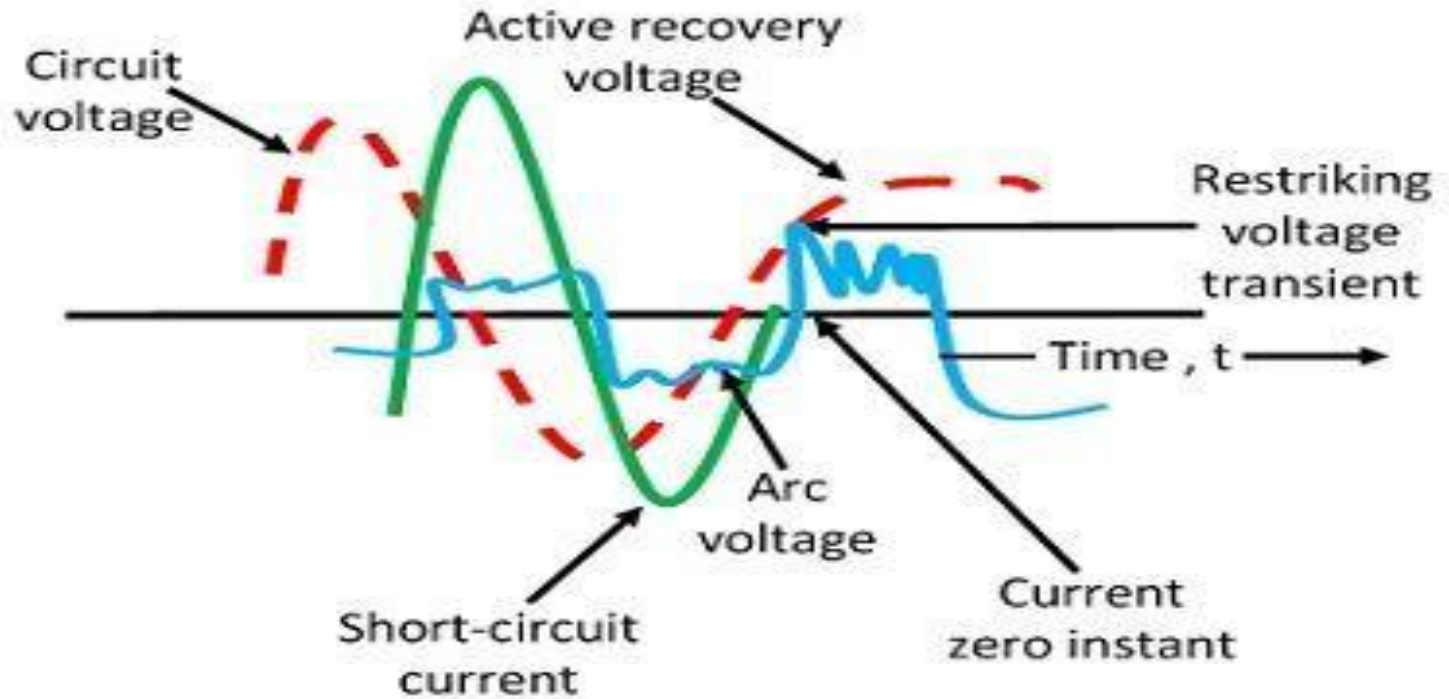

**Arc Extinction**

Circuit Globe

# ***Energy Balance Theory***

- When the contact of circuit breaker are about to open, re striking voltage is zero, hence generated heat would be zero and when the contacts are fully open there is infinite resistance, therefore no production of heat again.
- We can conclude from this that the maximum generated heat is lying between these two cases

- Now this theory is based on the fact that, if the rate of generation of heat between the contacts of circuit breaker is lower than the rate at which heat between the contact is dissipated, then the established arc shall be extinguished successfully.
- Thus if it is possible to remove the generated heat by cooling, lengthening and splitting the arc at a high rate the generation, arc can be extinguished.

# ***Voltage Race Theory***

- The arc is due to the ionization of the gas between the contacts of the circuit breaker
- Thus the resistance at the initial stage is very small i.e. when the contact are closed and as the contact separates the resistance starts increasing.

- If we remove ions at the initial stage either by recombining them into neutral molecules or inserting insulation at a rate faster than the rate of ionization, the arc can be interrupted.
- The ionization at zero current depends on the restriking voltage.

- 
- The theory states that if the rate of rise of restriking voltage is lesser than the rate at which the dielectric strength of the medium increases, then the arc will be successfully extinguished.

- Conductance of arc = ionized electrons/cm<sup>3</sup>

$$= \frac{\text{Diameter of the arc}}{\text{length of arc}}$$

- The arc can be interrupted by increasing length of the arc or decreasing the diameter of the arc or removing the ionized particles

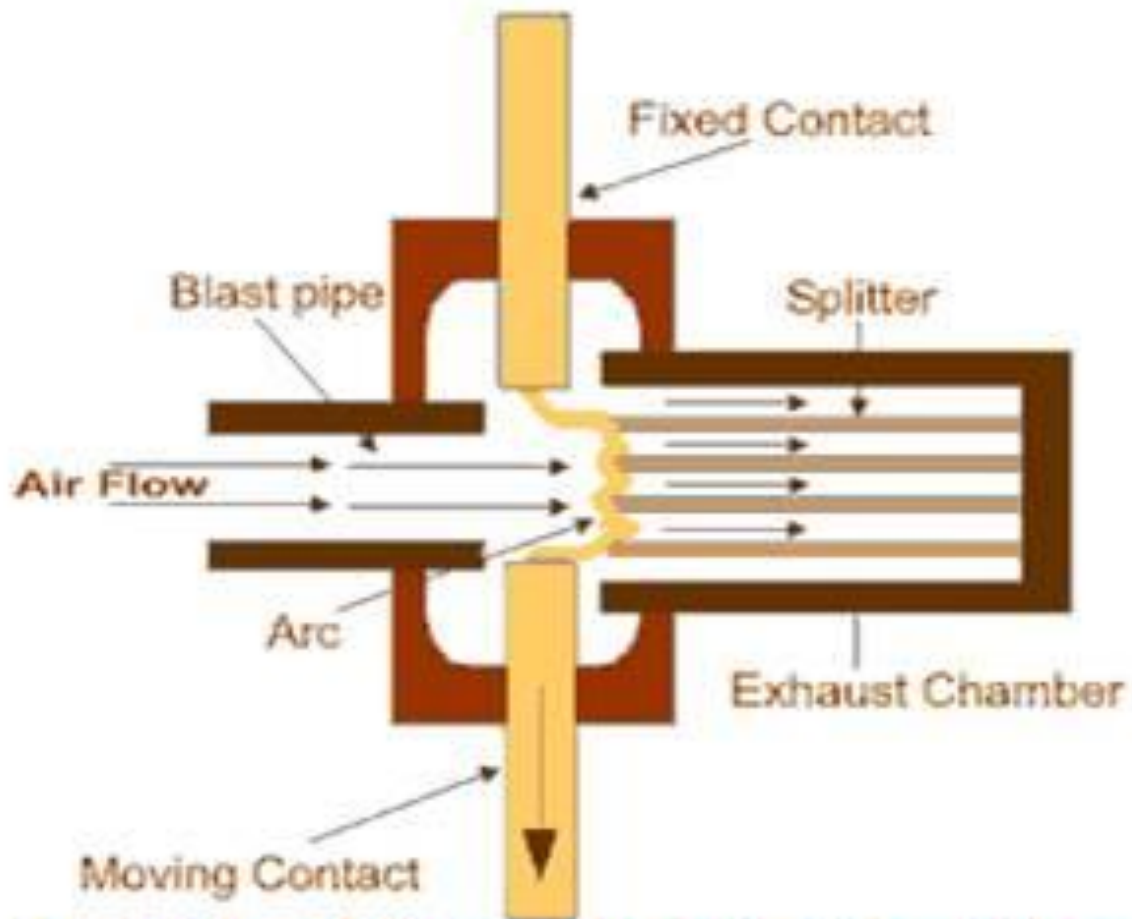

**Principle of Cross Blast Air Circuit Breaker**



# Splitters

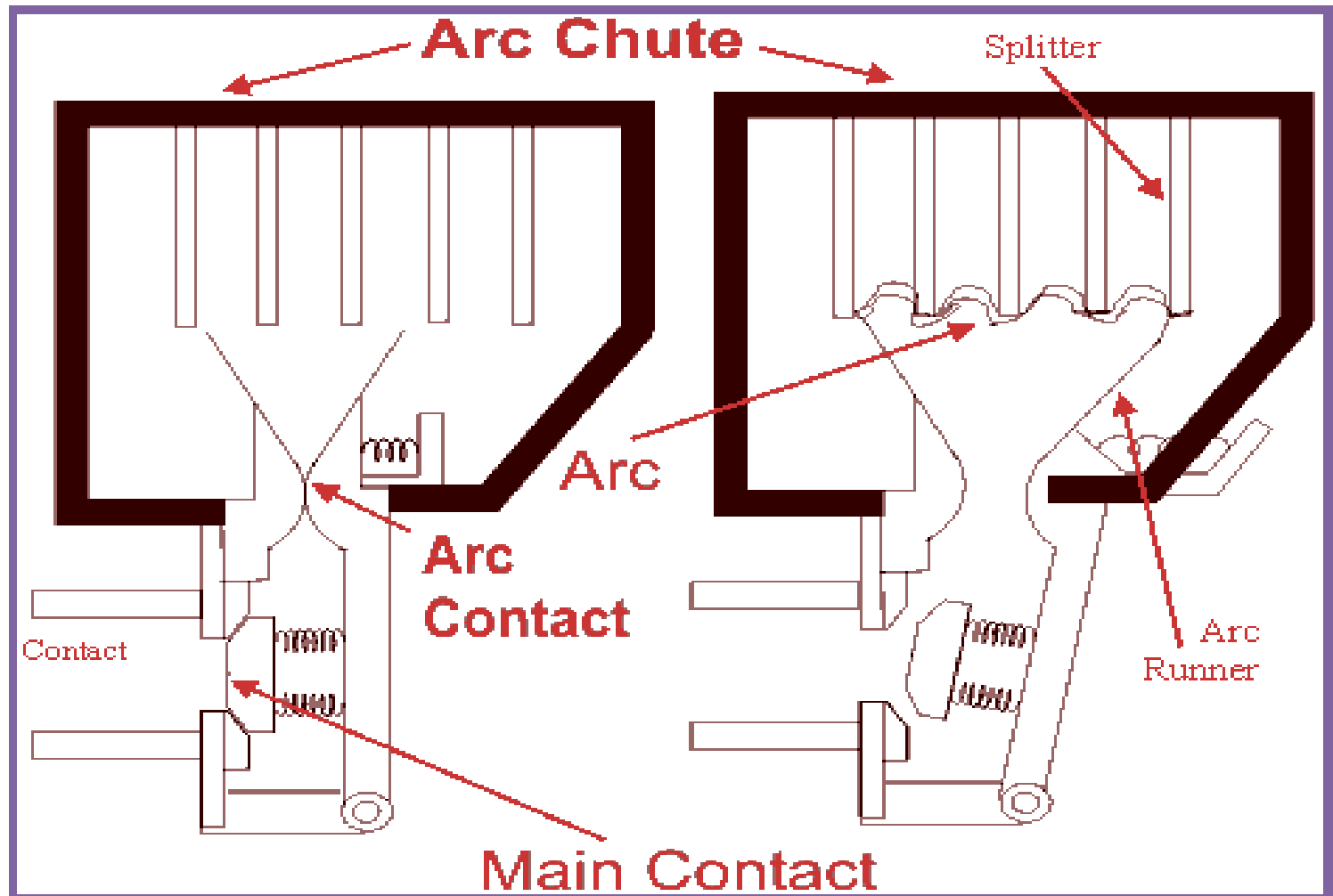

Rate of Rise of Restriking Voltage (RRRV)  
or Transient recovery voltage (TRV):

The average RRRV = Peak value of  
restriking voltage / Time taken to reach  
to peak value

$$\text{RRRV} = 2V_m$$

isolated.

*Rate of Rise of Restriking Voltage (RRRV):* As shown in Fig 15.1(a),

$$\begin{aligned}\text{The average RRRV} &= \frac{\text{Peak value of restriking voltage}}{\text{Time taken to reach to peak value}} \\ &= \frac{2V_m}{\pi\sqrt{LC}}\end{aligned}$$

Rewriting the equation,

$$v = V_m \left( 1 - \cos \frac{t}{\sqrt{LC}} \right)$$

The RRRV is given by

$$\frac{dv}{dt} = \frac{V_m}{\sqrt{LC}} \sin \frac{t}{\sqrt{LC}}$$

This is maximum when

$$\frac{t}{\sqrt{LC}} = \frac{\pi}{2}$$

or

$$t = \frac{\pi}{2} \sqrt{LC}$$

and the value is  $\frac{V_m}{\sqrt{LC}}$

# Current Chopping

- When a circuit breaker is made to interrupt low inductive currents such as currents due to no load magnetizing current of a transformer,
- The current actually is forced to zero before it passes through natural zero value especially when the breaker exerts the same deionizing force for all currents within its short circuit capacity.
- This breaking of current before it passes through the natural zero is termed as current chopping.

# Current Chopping

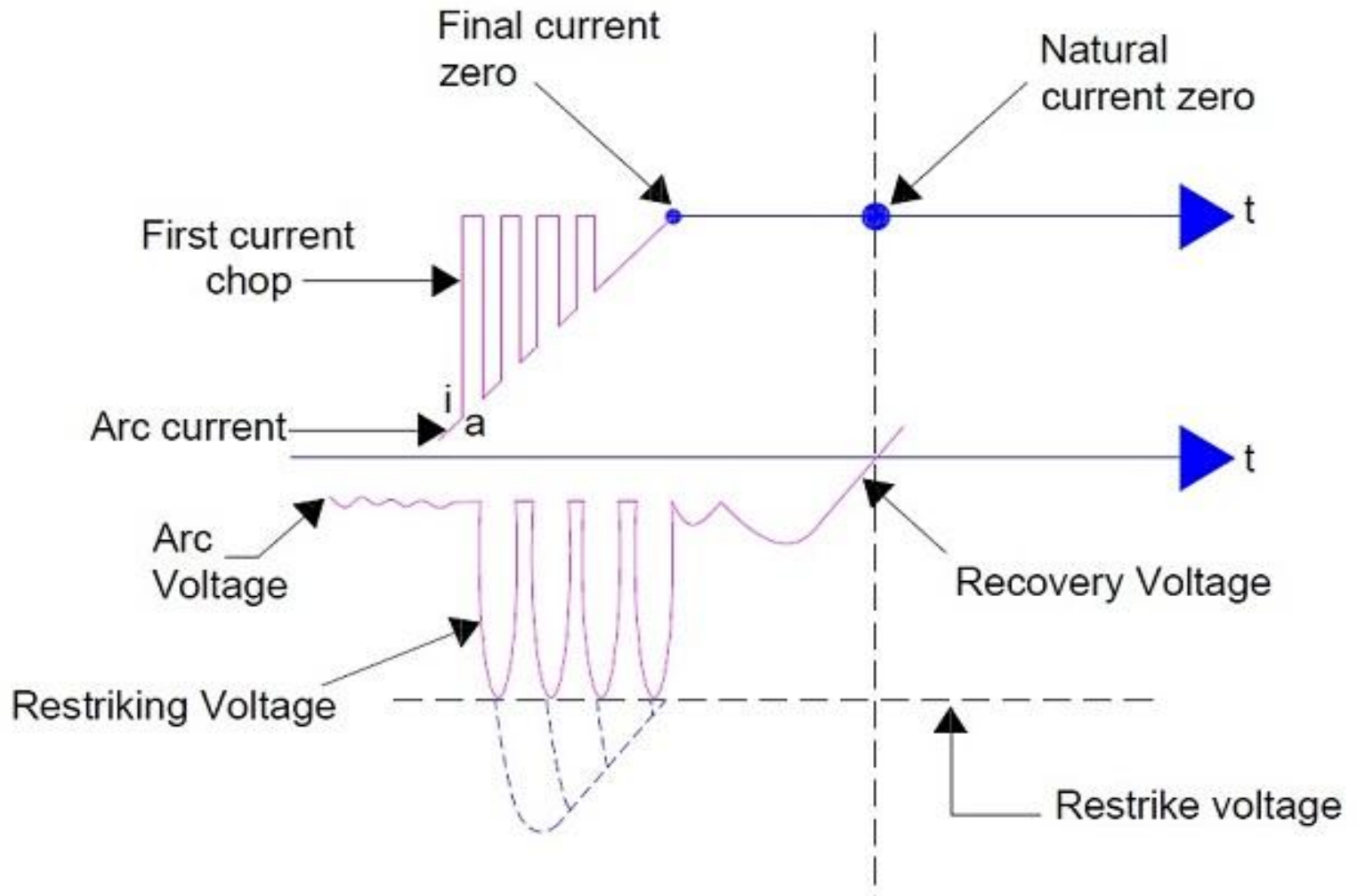

- This current chopping may take place even in breakers which produce varying degree of deionizing force.
- The effect of a practically instantaneous collapse of the arc current, even of only a few amperes, is potentially very serious from the point of view of over-voltages which may result in the system.
- The arc current is seen to approach zero in normal fashion initially with low arc voltage so that there is virtually no capacitance current.

- At a certain arc current, because of the large deionizing force, the current suddenly reduces to zero.
- The current in the arc was flowing from the source through the inductance and the circuit breaker contacts.
- The energy contained in the electromagnetic field cannot become zero instantaneously. It changes into some other form of energy.

- The only possibility is the conversion from electromagnetic to electrostatic form of energy i.e., the current is diverted to the capacitor from the arc.
- If  $i_a$  is the instantaneous value of arc current where the chop takes place, the prospective value of voltage to which the capacitor will be charged, will be

$$V = i_a \sqrt{L / C}$$

where  $L$  is the series inductance and  $C$  the shunt capacitance.

- This voltage appears across the circuit breaker contacts.



- Fortunately, the breaker gap restrikes before the voltage is allowed to reach this value (prospective voltage which normally is very high as compared to the system voltage).
- The deionizing force is still in action and the current will again be chopped.
- Successive chops may occur until a final chop brings the current to a zero prematurely with no further restrike since the gap is now in an advanced stage of deionization.

# Resistance Switching

- During current chopping very high voltages may appear across the circuit breaker contacts and these voltages may endanger the operation of the system.
- To reduce these voltages, a resistance across the breaker contacts is connected

# Resistance Switching

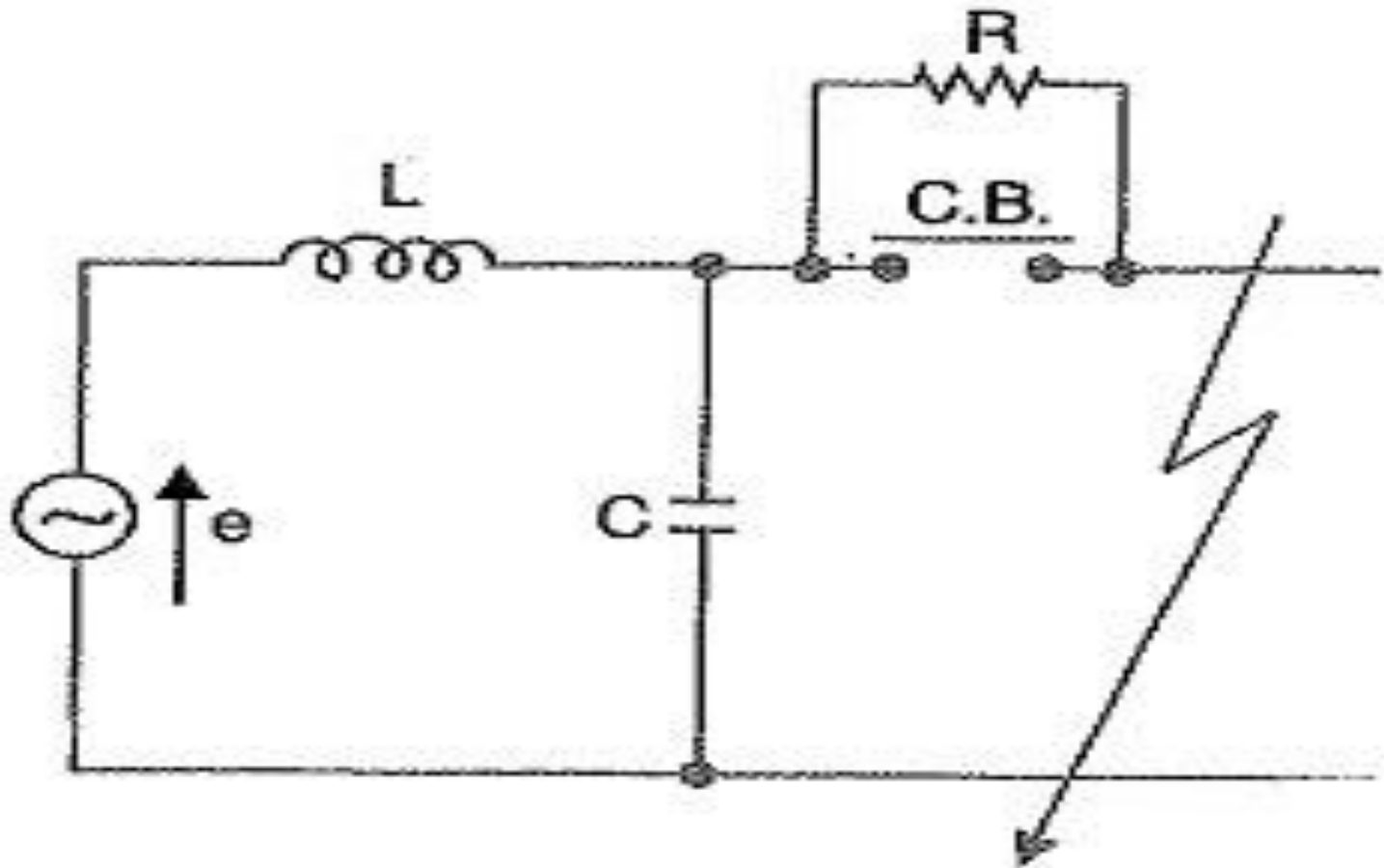



The shunt resistor performs one or more of the following functions:

- (i) It reduces the rate of rise of restriking voltage and thus reduces duties of the breaker.
- (ii) It reduces the transient voltages during switching out inductive or capacitive loads.
- (iii) In a multi-break circuit breaker they may be used to help to distribute the transient recovery voltage more uniformly across the several gaps.

- To reduce the transient recovery voltage requires a considerably lower value of resistor whereas for voltage equalization a resistor of relatively high ohmic value will be required.
- In this case it is required that its resistance be low compared with the reactance of the capacitance, shunting the breaks at the frequency of the recovery transient.
- It is often necessary to compromise and make one resistor do more than one of these jobs critical restriking voltage damping

The value of the resistance is calculated as

$$R = 0.5 \sqrt{\frac{L}{C}}$$

# Rating of circuit breakers

- 1) Rated short circuit breaking current.
- 2) Rated short circuit making current.
- 3) Rated operating sequence of circuit breaker.
- 4) Rated short time current.

# ***Rated voltage of circuit breaker***

- Rated voltage of circuit breaker depends upon its insulation system.
- For below 400 KV system, the circuit breaker is designed to withstand 10% above the normal system voltage
- For above or equal 400 KV system the insulation of circuit breaker should be capable of withstanding 5% above the normal system voltage.
- That means, rated voltage of circuit breaker corresponds to the highest system voltage.





- This is because during no load or small load condition the voltage level of power system is allowed rise up to highest voltage rating of the system.

- A circuit breaker is also subject to two other high voltage condition.

- 1) Sudden disconnection of huge load for any other cause, the voltage imposed on the CB and also between the contacts when the CB is open, may be very high compared to higher system voltage.

- 2) This voltage may be of power frequency but does not stay for very long period as this high voltage situation must be cleared by protective switchgear.

- But a circuit breaker may have to withstand this power frequency over voltage, during its normal life span.
- The Circuit Breaker must be rated for power frequencies withstand voltage for a specific time only.
- Generally the time is 60 seconds. Making power frequency withstand capacity, more than 60 second is not economical and not practically desired as all the abnormal situations of electrical power system are definitely cleared within much smaller period than 60 seconds.

- Like other apparatuses connected to power system, a circuit breaker may have also to face lightning impulse and switching impulses during its life span.
- The insulation system of CB has to withstand these impulse voltage waveform. So a circuit breaker is designed to withstand this impulse peaky voltage for microsecond range only.

| <b>NOMINAL SYSTEM VOLTAGE</b> | <b>HIGHEST SYSTEM VOLTAGE</b> | <b>POWER FREQUENCY WITHSTAND VOLTAGE</b> | <b>IMPULSE VOLTAGE LEVEL</b> |
|-------------------------------|-------------------------------|--|------------------------------|
| 11 KV                         | 12 KV                         | –  | –                            |
| 33 KV                         | 36 KV                         | 70 KV                                    | 170 KV                       |
| 132 KV                        | 145 KV                        | 275 KV                                   | 650 KV                       |
| 220 KV                        | 245 KV                        | 460 KV                                   | 1050 KV                      |
| 400 KV                        | 420 KV                        | –  | –                            |

## ***Short circuit breaking current of circuit breaker***

- This is the maximum short circuit current which a circuit breaker can withstand before it finally cleared by opening its contacts.
- When a short circuit flows through a circuit breaker, there would be thermal and mechanical stresses in the current carrying parts of the breaker.



The breaking current is expressed by two values.

- The *r.m.s* values of *a.c.* components are expressed in KA.
- The standard values being 8, 10, 12.5, 16, 20, 25, 31.5, 40, 45, 63, 80 and 100KA.

- The earlier practice was to express the rated breaking capacity of a circuit breaker in terms of MVA given as follows

$$\text{Rated Breaking MVA} = \sqrt{3} \times \text{KV} \times \text{KA}$$

Where  $\text{kV} = \text{Rated voltage}$

$\text{kA} = \text{Rated breaking current}$

- The rated values of transient recovery voltage are specified for various rated voltage of circuit breakers.
- For specified conditions of rated TRV and rated power frequency recovery voltage, a circuit breaker has a certain limit of breaking current.
- This limit is determined by conducting short circuit type tests on the circuit breaker. The waveforms of short circuit current are obtained during the breaking test.



- This practice of specifying the breaking capacity in terms of MVA is convenient while calculating the fault levels.
- However, as per the revised standards, the breaking capacity is expressed in KA for specified conditions of TRV and this method takes into account both breaking current and TRV.
- The breaking capacity can be both symmetrical and asymmetrical in nature. In asymmetrical breaking capacity the DC component of the current is added.
- While selecting the circuit breaker for a particular location in the power system the fault level at that location is determined. The rated breaking current can then be selected from standard range.

## ***Rated short circuit making capacity***

- The short circuit making capacity of circuit breaker is expressed in peak value not in rms value like breaking capacity.
- It may so happen that circuit breaker may close on an existing fault. In such cases the current increase to the maximum value at the peak of first current loop.

- The circuit breaker should be able to close without hesitation as contact touch. The circuit breaker should be able to withstand the high mechanical forces during such a closure.
- These capabilities are proved by carrying out making current test.
- The rated short circuit making current of a circuit breaker is the peak value of first current loop of short circuit current ( $I_{pk}$ ) which the circuit breaker is capable of making at its rated voltage.

- The rated short circuit making current should be least 2.5 times the r.m.s. value of a.c. component of rated breaking current .

$$\begin{aligned}\text{Rated making current} &= 1.8 \times \sqrt{2} \times \text{Rated short circuit} \\ &\text{breaking} \\ &= 2.5 \times \text{Rated short circuit breaking current}\end{aligned}$$

In the above equation the factor  $\sqrt{2}$  convert the r.m.s value to peak value.

- Factor 1.8 takes into account the doubling effect of short circuit current with consideration to slight drop in current during the first quarter cycle .

# Rated operating sequence or duty cycle of circuit breaker

- This is mechanical duty requirement of circuit breaker operating mechanism.
- The sequence of rated operating duty of a circuit breaker has been specified as

$$O - t - CO - t'' - CO$$

Where  $O$  indicates opening operation of the CB.

$CO$  represents closing operation immediately followed by an opening operation without any intentional time delay.

$t''$  is time between two operations which is necessary to restore the initial conditions and / or to prevent undue heating of conducting parts of circuit breaker.

$t = 0.3$  sec for circuit breaker intended for first auto reclosing duty, if not otherwise specified.

- Suppose rated duty circle of a circuit breaker is

O – 0.3 sec – CO – 3 min – CO.

- This means, an opening operation of circuit breaker is followed by a closing operation after a time interval of 0.3 sec, then the circuit breaker again opens without any intentional time delay.
- After this opening operation the CB is again closed after 3 minutes and then instantly trips without any intentional time delay.

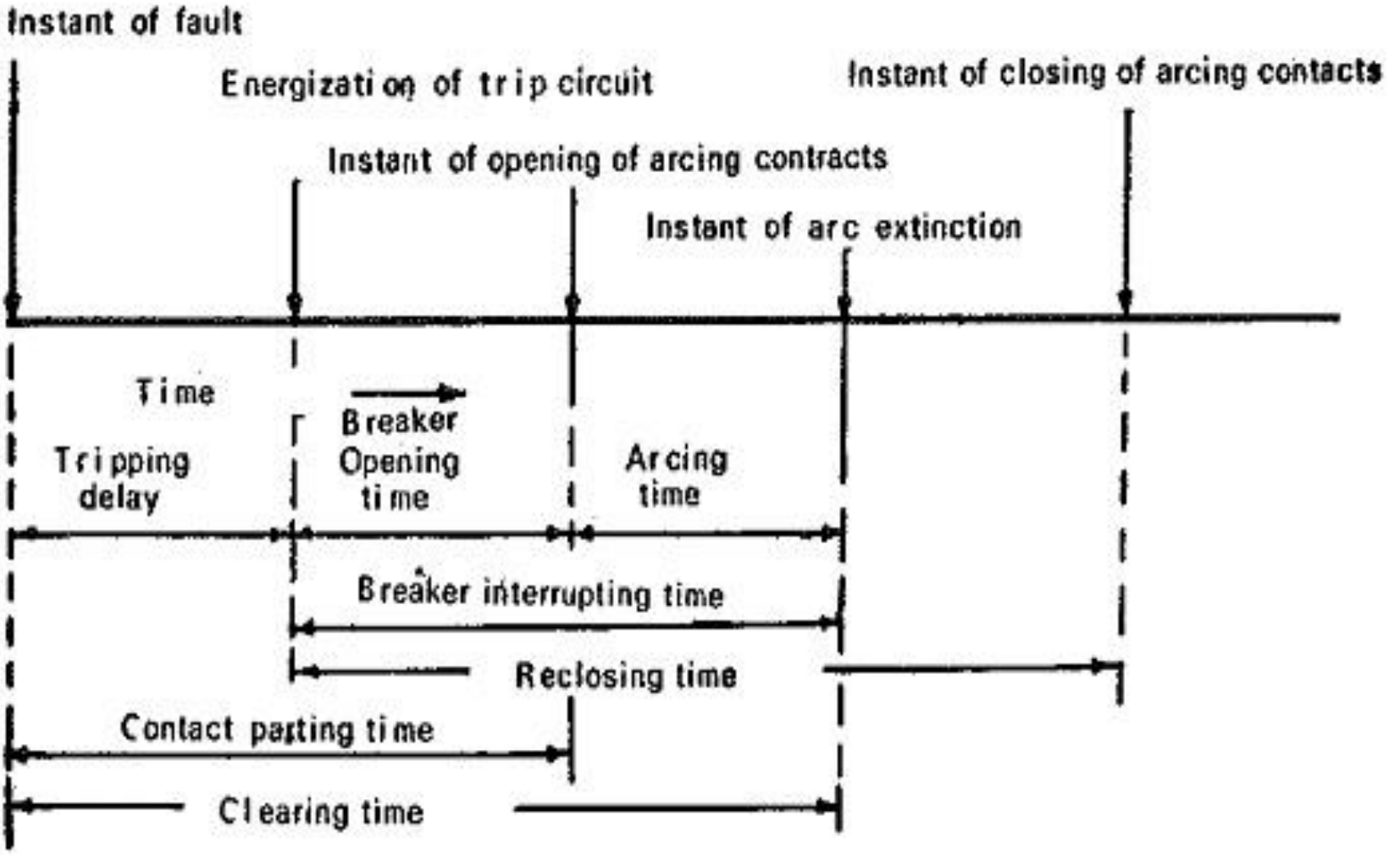

**FIGURE 14.2** Various components of operating time of circuit breaker.

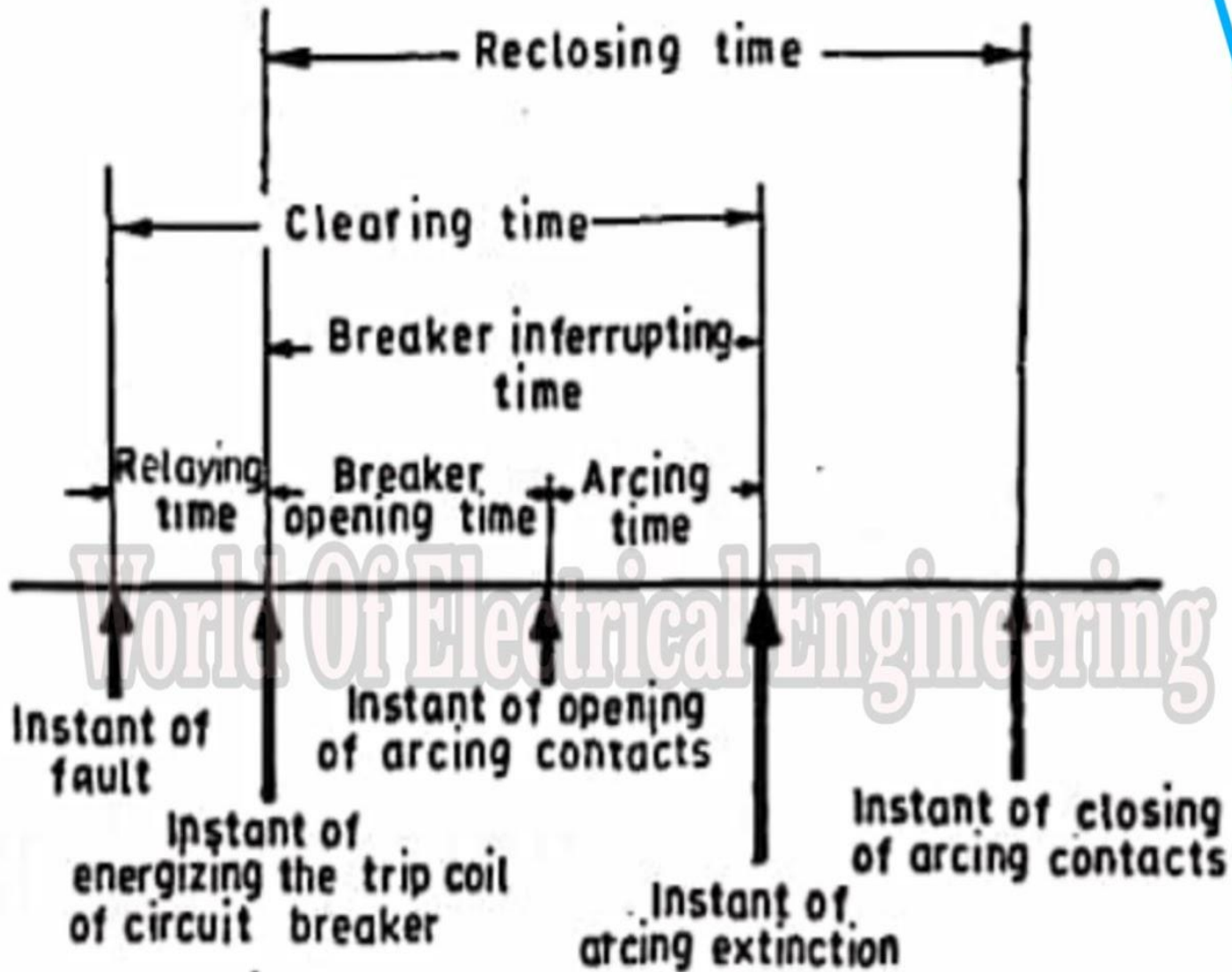



# ***Rated short time current***

- This is the current limit which a circuit breaker can carry safely for certain specific time without any damage.
- The circuit breakers do not clear the short circuit current as soon as any fault occurs in the system.
- There always some intentional time delays present between the instant of occurrence of fault and instant of clearing the fault by CB.

- 
- This delay is imposed in relay for proper coordination of power system protection
  - Hence, after fault, a circuit breaker has to carry the short circuit current for certain time.
  - The summation of all time delays should not be more than 3 seconds, hence a circuit breaker should be capable of carrying a maximum fault current for at least this short period of time.

- The short circuit current may have two major affects inside a circuit breaker.

1. There will be high thermal stress in the insulation and conducting parts of CB.

2. It produces significant mechanical stresses in different current carrying parts of the circuit breaker.

- A circuit breaker is designed to withstand these stresses.
- But no circuit breaker can carry not more than a short period depending upon the coordination of protection.
- So it is sufficient to make CB capable of withstanding affects of short circuit current for a specified short period.
- The rated short time current of a circuit breaker is at least equal to rated short circuit breaking current of the circuit breaker.



**THANK YOU**